



ELECTRIC COUNTERBALANCE TRUCK E16 | E20

CAPACITY 1600 - 2000 KG | SERIES 1275

Safety

Outstanding stability and excellent traction achieved by a design that incorporates a high-level engineering expertise and high-quality materials. The advanced drive axle concept provides benchmarking truck driving experience by automatically moving forward when the mast is tilted back.

Performance

Very well known as electric trucks with IC truck performance, Linde electric trucks are equipped with powerful electric motors and an intelligent electronic control. Both of these together form an impressive and compact powerpack to deliver a benchmarking productivity.

Comfort

A consistently high level of efficiency for extended working periods is only possible with ergonomic design. The ergonomic system of all

truck controls, an adjustable armrest with integrated mini levers, and the twin pedal system provides the optimum interface between the truck and its operator.

Reliability

Fully sealed aluminium component housings provide a superb protection from dust and dirt ingress. European manufactured cutting edge drive and lift motors and contact free hydraulic mini levers underline the premium standard of this electric truck.

Service

Four different battery changing solutions, maintenance free AC motors and wet disc brakes are lowering the truck down time to a minimum to ensure the lowest service cost level possible. Easy and quick diagnosis are realised through the Linde digital control system.

TECHNICAL DATA

ACCORDING TO VDI 2198

				Linde	Linde	Linde
Characteristics	1.1	Manufacturer		Linde	Linde	Linde
	1.2	Model designation		E16 C -00	E16 CH -00	E16 P -00
	1.3	Power unit		Battery	Battery	Battery
	1.4	Operation		Seat	Seat	Seat
	1.5	Load capacity	Q (t)	1.6	1.6	1.6
	1.6	Load centre	c (mm)	500	500	500
	1.8	Axle centre to fork face	x (mm)	335	335	335
	1.9	Wheelbase	y (mm)	1356 ²⁾	1383 ²⁾	1442 ²⁾
	Weights	2.1	Service weight	kg	3180	3465
2.2		Axle load with load, front/rear	kg	4165/615 ²⁾	4281/784 ²⁾	4156/554 ²⁾
2.3		Axle load without load, front/rear	kg	1580/1600 ²⁾	1715/1750 ²⁾	1630/1480 ²⁾
Wheels and tyres	3.1	Tyre: SE=(super elastic), P=(pneumatic)		SE	SE	SE
	3.2	Tyre size, front		18 x 7-8	200/50-10	18 x 7-8
	3.3	Tyre size, rear		15 x 4 1/2-8	15 x 4 1/2-8	16 x 6-8
	3.5	Wheels, number front/rear (x = driven)		2x/2	2x/2	2x/2
	3.6	Track width, front	b10 (mm)	925	945	925
	3.7	Track width, rear	b11 (mm)	168	168	874
Dimensions	4.1	Mast tilt, forward/backward	α/β (°)	5.7/6.5	5.7/6.5	5.7/7.5
	4.2	Height of mast, lowered	h1 (mm)	2194	2192	2194
	4.3	Free Lift	h2 (mm)	150	150	150
	4.4	Lift	h3 (mm)	3250	3250	3250
	4.5	height of mast, extended	h4 (mm)	3861	3861	3861
	4.7	Height of overhead guard (cabin)	h6 (mm)	2018	2176	2018
	4.8	Height of seat platform	h7 (mm)	990	1150	990
	4.12	Tow coupling height	h10 (mm)	529	614	563
	4.19	Overall length	l1 (mm)	2880 ²⁾	2908 ²⁾	2983 ²⁾
	4.20	Length to fork face	l2 (mm)	1880 ²⁾	1908 ²⁾	1983 ²⁾
	4.21	Overall width	b1/b2 (mm)	1083	1158	1083
	4.22	Fork dimensions sxexl	s/e/l (mm)	45 x 100 x 1000	45 x 100 x 1000	45 x 100 x 1000
	4.23	Fork carriage to ISO 2328, class/type A,B		2A	2A	2 A
	4.24	Width of fork carriage	b3 (mm)	1040	1040	1040
	4.31	Ground clearance, mast	m1 (mm)	95	95	90
	4.32	Ground clearance, center of wheelbase	m2 (mm)	110	110	105
	4.33	Aisle width with pallet 1000 x 1200 mm across forks	Ast (mm)	3212 ²⁾	3241 ²⁾	3408 ²⁾
	4.34	Aisle width with pallet 800 x 1200 mm along forks	Ast (mm)	3334 ²⁾	3363 ²⁾	3605 ²⁾
	4.35	Turning radius	Wa (mm)	1548 ²⁾	1577 ²⁾	1870 ²⁾
	Performances	4.36	Minium pivoting distance	b13 (mm)	0	0
5.1		Travel speed, with/without load	km/h	15.8/15.8	15/15	15.8/15.8
5.2		Lifting speed,with/without load	m/s	0.44/0.57	0.44/0.57	0.44/0.57
5.3		Lowering speed, with/without load	m/s	0.54/0.54	0.54/0.54	0.54/0.54
5.5		Tractive force, with/without load	N	2900/3400	4400/4500	3400/3400
5.6		Maximum tractive force, with/without load	N	11000/7300	10700/8900	11000/8400
5.7		Climbing ability,with/without load	%	6.1/10.8	8.9/13.4	7.3/11.1
5.8		Maximum climbing ability,with/without load	%	21.7/21.4	19.7/24.4	22.1/25.8
5.9		Acceleration time,with/without load	s	6.0/5.8	6.8/6.5	6.3/6.2
5.10		Service brake				Hydraulic/electric
Drive	6.1	Drive motor hour rating	kW	2 x 4	2 x 4	2 x 4
	6.2	Lift motor, 15 % rating	kW	8.5	8.5	8.5
	6.3	Battery according to DIN43 535/36 A/B/C/no		43531A	43531A	43531 A
	6.4	Battery voltage/capacity (5 hours)	V/Ah	48/575	48/700	48/575
	6.5	Battery weight (+/- 5 %)	kg	856	1118	856
	6.6	Power Consumption according to VDI cycle	kWh/h	4.7	5.0	4.8
Others	8.1	Type of drive control		Microprocessor	Microprocessor	Microprocessor
	8.2	Working pressure for attachments	bar	200	200	200
	8.3	Oil flow for attachments	(l/min)	20	20	20
	8.4	Noise level at driver's ear	db(A)	-	-	-

TECHNICAL DATA

ACCORDING TO VDI 2198

				Linde	Linde
Characteristics	1.1	Manufacturer		Linde	Linde
	1.2	Model designation		E16 PH -00	E20 PH -00
	1.3	Power unit		Battery	Battery
	1.4	Operation		Seat	Seat
	1.5	Load capacity	Q (t)	1.6	2.0
	1.6	Load centre	c (mm)	500	500
	1.8	Axle centre to fork face	x (mm)	335	339
	1.9	Wheelbase	y (mm)	1472 ²⁾	1472 ²⁾
	Weights	2.1	Service weight	kg	3445
2.2		Axle load with load, front/rear	kg	4263/782 ²⁾	4885/655 ²⁾
2.3		Axle load without load, front/rear	kg	1755/1690 ²⁾	1750/1790 ²⁾
Wheels and tyres	3.1	Tyre: SE=(super elastic), P=(pneumatic)		SE	SE
	3.2	Tyre size, front		18 x 7-8	20/50-10
	3.3	Tyre size, rear		16 x 6-8	16 x 6-8
	3.5	Wheels, number front/rear (x = driven)		2x/2	2x/2
	3.6	Track width, front	b10 (mm)	925	945
	3.7	Track width, rear	b11 (mm)	874	874
	Dimensions	4.1	Mast tilt, forward/backward	α/β (°)	5.7/7.5
4.2		Height of mast, lowered	h1 (mm)	2196	2196
4.3		Free Lift	h2 (mm)	150	150
4.4		Lift	h3 (mm)	3250	3250
4.5		height of mast, extended	h4 (mm)	3861	3863
4.7		Height of overhead guard (cabin)	h6 (mm)	2173	2173
4.8		Height of seat platform	h7 (mm)	1150	1150
4.12		Tow coupling height	h10 (mm)	644	645
4.19		Overall length	l1 (mm)	3018 ²⁾	3060 ²⁾
4.20		Length to fork face	l2 (mm)	2018 ²⁾	2060 ²⁾
4.21		Overall width	b1/b2 (mm)	1158	1158
4.22		Fork dimensions sxexl	s/e/l (mm)	45 x 100 x 1000	45 x 100 x 1000
4.23		Fork carriage to ISO 2328, class/type A,B		2A	2A
4.24		Width of fork carriage	b3 (mm)	1040	1040
4.31		Ground clearance, mast	m1 (mm)	90	90
4.32		Ground clearance, center of wheelbase	m2 (mm)	105	105
4.33		Aisle width with pallet 1000 x 1200 mm across forks	Ast (mm)	3480 ²⁾	3484 ²⁾
4.34		Aisle width with pallet 800 x 1200 mm along forks	Ast (mm)	3680 ²⁾	3684 ²⁾
4.35		Turning radius	Wa (mm)	1945 ²⁾	1945 ²⁾
Performances		4.36	Minium pivoting distance	b13 (mm)	598
	5.1	Travel speed, with/without load	km/h	15.8/15.8	15.8/15.8
	5.2	Lifting speed,with/without load	m/s	0.44/0.57	0.37/0.57
	5.3	Lowering speed, with/without load	m/s	0.54/0.54	0.54/0.54
	5.5	Tractive force, with/without load	N	4400/4500	3000/3300
	5.6	Maximum tractive force, with/without load	N	12300/11100	9500/10000
	5.7	Climbing ability,with/without load	%	8.9/13.4	6.0/8.6
	5.8	Maximum climbing ability,with/without load	%	23.2/31.8	15.5/27.3
	5.9	Acceleration time,with/without load	s	6.2/6.2	6.2/5.8
	5.10	Service brake			
Drive	6.1	Drive motor hour rating	kW	2 x 4	2 x 4
	6.2	Lift motor, 15 % rating	kW	8.5	8.5
	6.3	Battery according to DIN43 535/36 A/B/C/no		43531A	43531A
	6.4	Battery voltage/capacity (5 hours)	V/Ah	48/700	48/700
	6.5	Battery weight (+/- 5 %)	kg	1118	1118
	6.6	Power Consumption according to VDI cycle	kWh/h	5.0	5.1
Others	8.1	Type of drive control		Microprocessor	Microprocessor
	8.2	Working pressure for attachments	bar	200	250
	8.3	Oil flow for attachments	(l/min)	20	20
	8.4	Noise level at driver's ear	db(A)	-	-

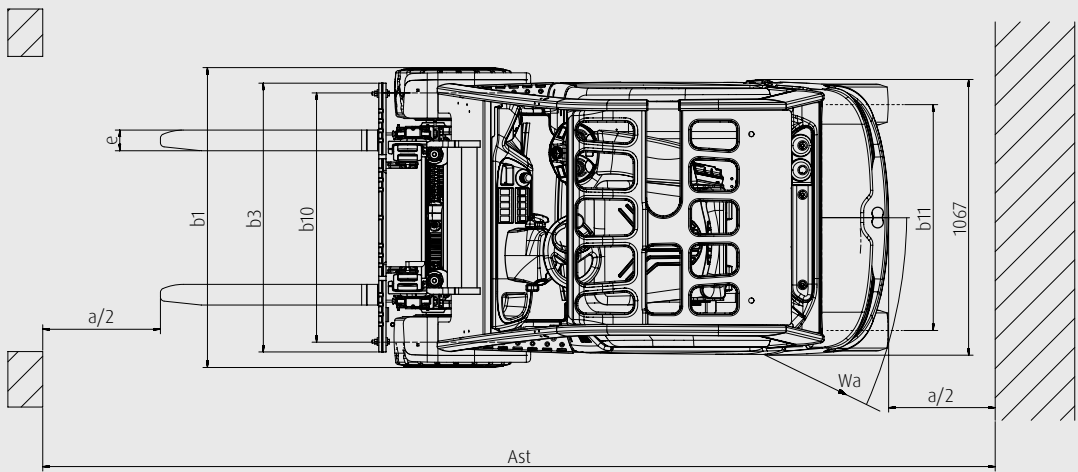

MAST TABLES

Standard masts (mm)		E16 C/E16 P							E16 CH/E16 PH/E20 PH					
Lift height	h_3	2850	3050	3250	3850	4250	4850	5650	3050	3250	3850	4250	4850	5650
Retracted height with 150 mm free lift	h_1	1976	2076	2176	2476	2676	2976	3376	2078	2178	2478	2678	2978	3378
Height of overall at max. lift	h_4	3643	3663	3863	4463	4863	5463	6263	3663	3863	4463	4863	5463	6263
Free lift	h_2	150	150	150	150	150	150	150	150	150	150	150	150	150

Duplex masts (mm)		E16 C/E16 P							E16 CH/E16 PH/E20 PH					
Lift height	h_3	2770	3070						3070					
Retracted height with 150 mm free lift	h_1	1919	2069						2071					
Height of overall at max. lift	h_4	3383	3683						3683					
Free lift	h_2	1318	1468						1468					

Duplex masts (mm)		E16 C/E16 P							E16 CH/E16 PH/E20 PH					
Lift height	h_3	4020	4470	4770	5470	5920	6220		4470	4770	5470	5920	6220	
Retracted height with 150 mm free lift	h_1	1919	2069	2169	2469	2619	2719		2071	2171	2471	2621	2721	
Height of overall at max. lift	h_4	4633	5083	5383	6533	6533	6833		5083	5383	6083	6583	6883	
Free lift	h_2	1318	1468	1568	1868	2018	2118		1468	1568	1868	2018	2118	

LIFTING CAPACITY DIAGRAM

WITH STANDARD FORK CARRIAGE

STANDARD, DUPLEX MAST

E16 C

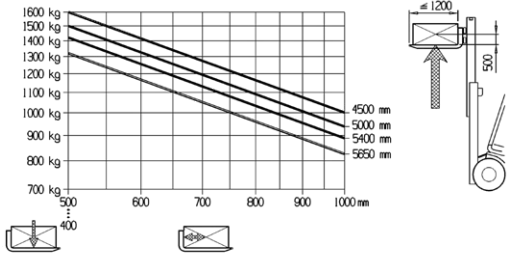

TRIPLEX MAST

E16 C

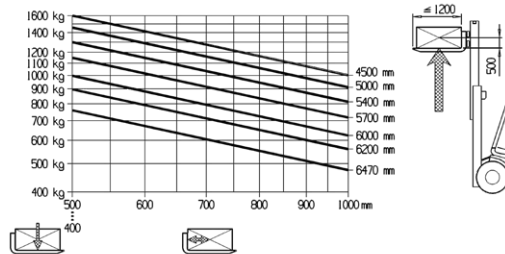

E16 CH

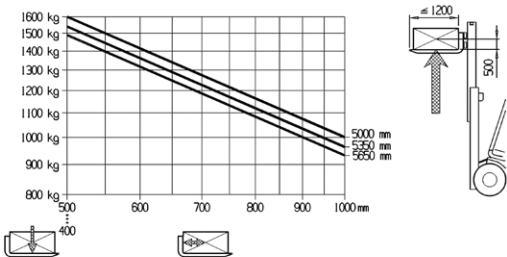

E16 CH

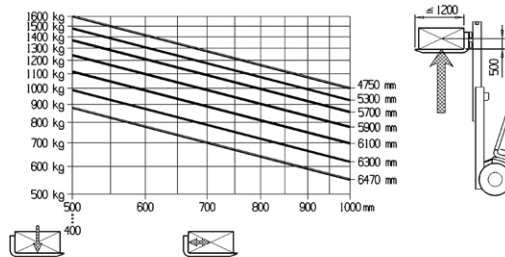

E16 P

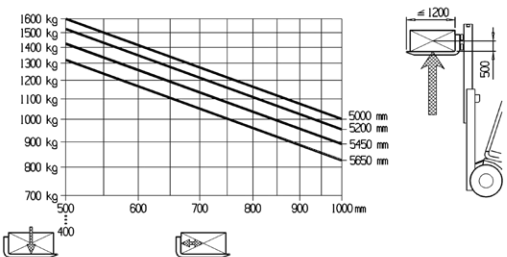

E16 P

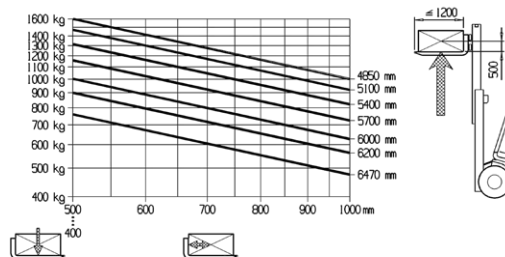

E16 PH

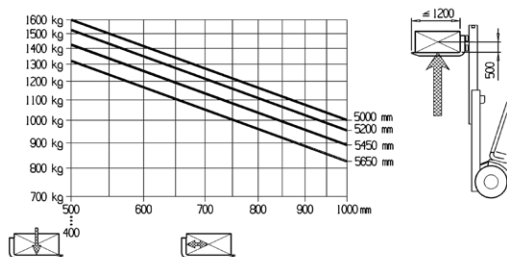

E16 PH

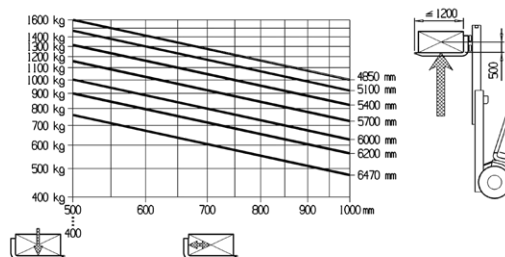

E20 PH

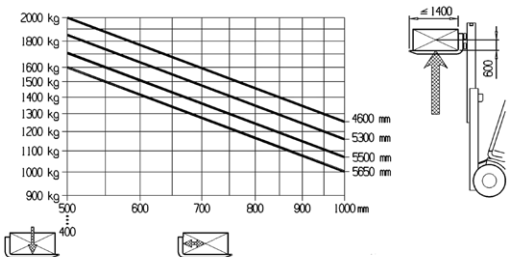

E20 PH

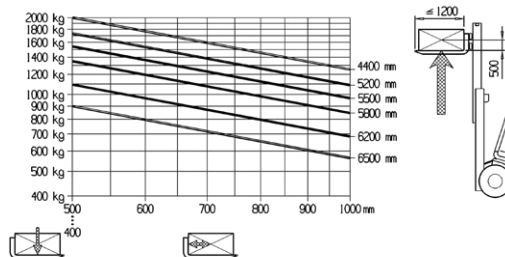

STANDARD EQUIPMENT / OPTIONAL EQUIPMENT

STANDARD EQUIPMENT

Linde twin pedal system
Linde Load Control integrated in armrest
2 x KW maintenance AC drive motors
180° degree battery door opening for vertical/lateral battery change
Linde Curve Assist
Adjustable PVC seat, adapts to operator's body size and weight
Multifunction LCD display
Battery capacity 48 V / 575-700 Ah
SE tyres
Adjustable steering column

OPTIONAL EQUIPMENT

Single drive pedal with direction lever in armrest
Truck lighting
Several fork lengths
Fork carriage
Standard masts, lift height up to 5650 mm
Duplex masts (full free lift), lift height up to 3070 mm
Triplex masts (full free lift), lift height up to 6220 mm
Integrated sideshift
One, two additional hydraulic circuits for attachments
Fork extensions
Load backrest
Full cabin with doors
Front and rear screens, wipers and top screen
Comfort seat
Bluespot™
Individual colour
Audible warning in reverse
Flashing beacon
Linde connect: Flottenmanagement
Li-ION ready

FEATURES

Linde operator compartment

- Ergonomic design for efficient and fatigue-free working
- Spacious compartment with comfortable footwell and adjustable seat
- Small diameter steering wheel
- Adjustable steering column
- Various storage compartments



Flexible battery change solutions

- Standard 180° battery door for vertical and lateral battery change
- Flexible battery change solutions for different applications and customer needs
- Quick battery change to reduce the down time

Adaptive drive axle

- Moving front axle
- Enhanced stability for distance travel
- Increase maneuverability in confined areas

Safe operation

- Patented high pivoting Linde steering axle
- Outstanding residual capacity
- Large step in plate with anti slip design



Linde Twin Pedals System

- Quick change of forward/reverse direction without changing feet on pedals
- Increased productivity
- Fatigue-free working

Linde Load Control

- Safe and accurate load handling
- Effortless fingertip control of all mast functions
- Hydraulic control levers integrated in armrest
- Wide and cushioned armrest

Linde clear-view mast

- Superb visibility through slim-profile sections of mast
- Full load capacity up to maximum lift height
- Exceptional residual capacity

Subject to modification in the interest of progress. Illustrations and technical details could include options and not binding for actual constructions. All dimensions subject to usual tolerances.

Linde Material Handling

Linde

Linde Material Handling | 5 Distillers Place | Huntingwood NSW 2148
Phone 1300 135 463 | www.lindemh.com.au